

Fishfinder 240



owner's
manual

© 2000 GARMIN Corporation

GARMIN International, Inc.
1200 East 151st Street, Olathe, Kansas 66062, U.S.A.
Tel. 913/397.8200 or 800/800.1020
Fax 913/397.8282

GARMIN (Europe) Ltd.
Unit 5, The Quadrangle, Abbey Park Industrial Estate, Romsey, SO51 9AQ, U.K.
Tel. 44/1794.519944
Fax 44/1794.519222

GARMIN (Asia) Corporation
No. 68, Jangshu 2nd Road, Shijr, Taipei County, Taiwan
Tel. 886/2.2642.9199
Fax 886/2.2642.9099

All rights reserved. Except as expressly provided herein, no part of this manual may be reproduced, copied, transmitted, disseminated, downloaded or stored in any storage medium, for any purpose without prior written consent of GARMIN Corporation. GARMIN Corporation hereby grants permission to download a single copy of this manual onto a hard drive or other electronic storage medium to be viewed for personal use, provided that such electronic or printed copy of this manual contains the complete text of this copyright notice and provided further that any unauthorized commercial distribution of this manual is strictly prohibited.

Information in this manual is subject to change without notice. GARMIN Corporation reserves the right to change or improve its products and to make changes in the content without obligation to notify any person or organization of such changes. Visit the GARMIN website (www.garmin.com) for current updates and supplemental information concerning the use and operation of this and other GARMIN products.

GARMIN and Fishfinder 100 are registered trademarks of GARMIN Corporation and may not be used without the express permission of GARMIN Corporation.

Customer Service Product Registration

Help us better support you by completing our on-line registration today! Have the serial number of your Fishfinder 240 handy and connect to our website (www.garmin.com). Look for the Product Registration link on the Home page.

Why should you register your Fishfinder 240?

- Notification of Product Updates
- Notification of New Products
- Lost or Stolen unit tracking

NOTE: If you have previously registered your GARMIN product purchase using a mail-in registration card, we invite you to re-register using our NEW on-line system. Many services provided by our new product registration system are now being automated and re-registering your purchase ensures you the best possible support from GARMIN.

Thank You for choosing the GARMIN Fishfinder 240. This product is designed for easy operation and to provide years of reliable service.

Please take the time to read this Owner's Manual, and learn the operation of your new unit. This will help ensure that you get the most from the Fishfinder 240.

If you encounter a problem, or just have a question, contact our Product Support Department at 913-397-8200, Monday — Friday 8:00 a.m. to 5:00 p.m. Central Time.

Enjoy your new Fishfinder 240 and once again thank you for choosing GARMIN.

Introduction

Limited Warranty

GARMIN Corporation warrants this product to be free from defects in materials and manufacture for one year from the date of purchase. GARMIN will, at its sole option, repair or replace any components that fail in normal use. Such repairs or replacement will be made at no charge to the customer for parts or labor. The customer is, however, responsible for any transportation costs. This warranty does not cover failures due to abuse, misuse, accident or unauthorized alteration or repairs.

THE WARRANTIES AND REMEDIES CONTAINED HEREIN ARE EXCLUSIVE AND IN LIEU OF ALL OTHER WARRANTIES EXPRESS OR IMPLIED OR STATUTORY, INCLUDING ANY LIABILITY ARISING UNDER ANY WARRANTY OF MERCHANTABILITY OR FITNESS FOR A PARTICULAR PURPOSE, STATUTORY OR OTHERWISE. THIS WARRANTY GIVES YOU SPECIFIC LEGAL RIGHTS, WHICH MAY VARY FROM STATE TO STATE.

IN NO EVENT SHALL GARMIN BE LIABLE FOR ANY INCIDENTAL, SPECIAL, INDIRECT OR CONSEQUENTIAL DAMAGES, WHETHER RESULTING FROM THE USE, MISUSE, OR INABILITY TO USE THIS PRODUCT OR FROM DEFECTS IN THE PRODUCT. SOME STATES DO NOT ALLOW THE EXCLUSION OF INCIDENTAL OR CONSEQUENTIAL DAMAGES, SO THE ABOVE LIMITATIONS MAY NOT APPLY TO YOU.

To obtain warranty service, call the GARMIN Customer Service department (913-397-8200) for a returned merchandise tracking number. The unit should be securely packaged with the tracking number clearly marked on the outside of the package and sent freight prepaid and insured to a GARMIN warranty service station. A copy of the original sales receipt is required as the proof of purchase for warranty repairs. GARMIN retains the exclusive right to repair or replace the unit or software or offer a full refund of the purchase price at its sole discretion. SUCH REMEDY SHALL BE YOUR SOLE AND EXCLUSIVE REMEDY FOR ANY BREACH OF WARRANTY.

Packaging and Accessories

The Fishfinder 240 Standard Package contains the following items:

- Fishfinder 240
- Protective Front Cover
- Surface/Flush Mount Kit
- Wiring Adapter Cable
- Owner's Manual
- Quick Reference Guide
- *Transom Mount Transducer (w/depth/temp)

*** Optional**

Optional Transducers:

- 010-10107-00 Bronze Thru-Hull (w/depth/temp)
- 010-10177-00 Bronze Thru-Hull (w/depth/temp/speed)
- 010-10119-00 Plastic Thru-Hull (w/depth)
- 010-10224-00 Plastic In-Hull (depth only)
- 010-10249-00 Plastic Transom Mount (w/depth/temp)
- 010-10200-00 Trolling Motor Mount (w/depth/temp)
- 010-10225-00 Remote Temperature Sensor
- 010-10252-00 Speed Sensor

Accessories:

- 010-10170-00 10' Transducer Extension Cable
- 010-10170-01 20' Transducer Extension Cable
- 010-10269-00 Protective Front Cover

Introduction

Table of Contents

Introduction.....	i-vi
Customer Service	i
Limited Warranty	ii
Packaging and Accessories.....	iii
Unit Display	vi
Installation	1-9
Selecting A Transducer	1
Transom Mount Installation	2
In-hull Installation	3
Trolling Motor Installation.....	4
Wiring Harness Installation	5
Wiring to a Fuse Block	5-6
Display Installation (Surface Mount)	7
Display Installation (Flush Mount).....	8
Testing the Installation	9
Unit Operation.....	10-27
Using the Adjustment Bar	
Keypad Function	10
Range	12
Zoom	13
View.....	13
Gain	14
Setup Menu	
Chart	
Whiteline	16
Scroll Speed	16
Scale.....	17
Tools	
Noise Reject	18
Flasher	19
Simulator	19
Numbers	
Number Size	20
Battery Voltage.....	20
Temperature	21
Speed	21

Table of Contents

Alarms	
Fish Alarm	22
Shallow Water	22
Deep Water	23
Battery Voltage	23
System	
Contrast	24
Beeper	24
NMEA Output	24
Calibration	
Keel Offset	25
Water Type	25
Units	
Depth	26
Temperature	26
Speed	26
Memory	
Remember	27
Factory Setup	27
Software Version	27
On the Water	28-33
Understanding Sonar	28
Transducer Coverage	29
Understanding the Chart	30
Whiteline	31
Thermoclines	32
Simulator Mode	33
Appendix	34-40
Appendix A—Specifications	34
Appendix B—Alarm Messages and Icons	35
Appendix C—Fishfinder 240 Portable	36-37
Appendix D—Index	38-40

Fishfinder 240

Introduction

What can the Fishfinder 240 Display?

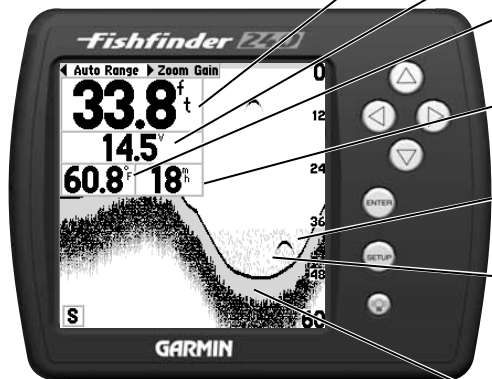

The Fishfinder 240 is able to display a variety of useful information about the underwater environment. Below are a few things the unit will help you see.

Water Depth

The unit displays water depth and can provide a warning for shallow or deep-water conditions.

Battery Voltage

The unit can display the battery voltage that is available to the unit.

Water Temperature*

If equipped with a capable transducer, the unit can display the water temperature.

Speed Over Water*

If equipped with a capable transducer or Speed Sensor, the unit can display the boat's speed over water.

Fish

The unit displays fish as arches or fish symbols and can alert you when a fish is detected.

Thermocline and Structure

With GARMIN's See-Thru® technology the Fishfinder 240 can display more than just the thermocline and structure, the unit displays fish in and below the thermocline, trees, brush and deadfall like you have never seen before!

Bottom Shape and Type

Garmin's unique DCG® (Depth Control Gain) system provides a clear graphic representation of the bottom type and its shape.

* requires optional transducer or sensor

Transducers

The transducer acts as the eyes and ears of your new sonar. Proper transducer selection and installation are critical to the operation of your unit.

The transducer transmits sound waves toward the bottom in a cone shape. The larger the cone angle the larger the coverage area at a given depth. While it is good to see as large of an area as possible, it is best to select a transducer that suits the water that you are on.

A wide cone angle transducer works best in shallow water. The wide cone angle provides a large coverage area, but at a decreased bottom resolution. In deeper water this can result in a large dead zone where fish cannot be seen.

A narrow cone angle transducer is better suited to deep-water installations. The narrow cone angle provides a smaller viewing area (compared to a wide cone angle transducer at the same depth) with improved bottom resolution and a smaller dead zone.

Included in the *Optional Package* is a 20° cone angle, temperature sensing, transom mount transducer. This transducer provides good all-around performance. A variety of optional transducers are available from your local dealer or GARMIN.

-Fishfinder 240

Installation

Selecting a Transducer

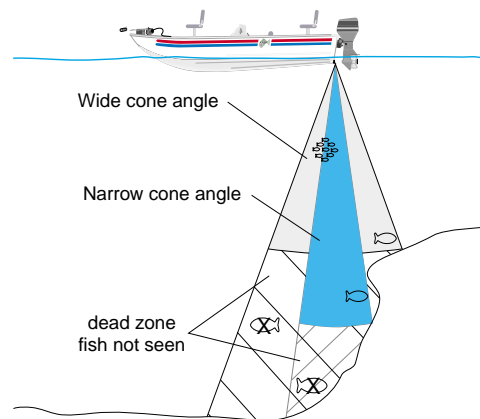

Installation

Mounting the Transducer



DO NOT mount the transducer behind strakes, struts, fittings, water intake or discharge ports, or anything that creates air bubbles or causes the water to become turbulent. It is important that the transducer be in calm, non turbulent water for optimal performance.

Proper transducer installation is key to getting the best performance from your new unit. If the transducer lead is too short, extension cables are available from your GARMIN dealer. **DO NOT** cut the transducer lead, this will void your warranty.

Following are some tips and basic installation instructions for three popular transducers. Detailed installation instructions are provided in the transducer kits.

Transom Mount Installation

010-10248-00 (depth/temp) Transom Mount Transducer.

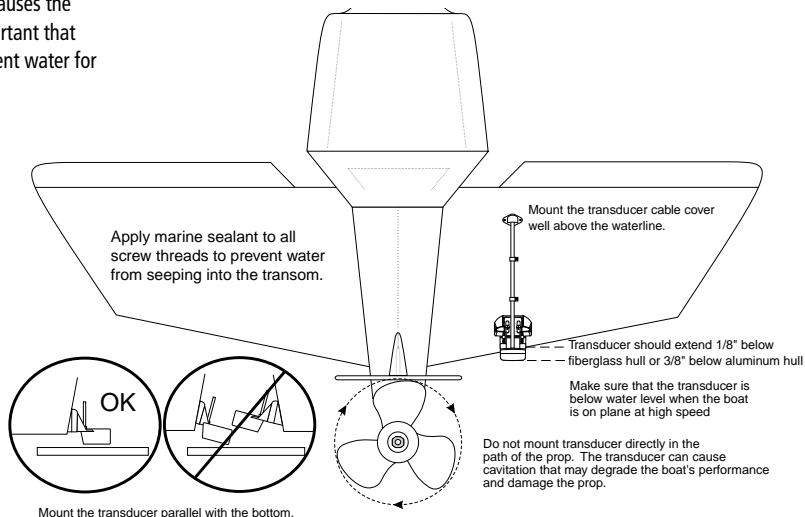

In-hull Installation

The 010-10224-00 transducer is designed to be mounted inside a fiberglass hull. The standard plastic transom mount transducer can also be mounted in this fashion using this method. If using a temperature sensing transducer, the temperature displayed will reflect the hull temperature.

Selecting a Location

The location has to be solid fiberglass, devoid of any air bubbles, laminates, fillers or dead air space. The location needs to be in an area of clean water at all speeds. Do not place the transducer over any strakes or behind any obstruction on the hull that would create turbulence at speed.



Many modern hulls have a prelocated pocket for In-hull transducer installation. If you are unsure if your hull is equipped with a prelocated pocket, contact your hull manufacturer.

Testing the Location

Place the transducer in the water, pointed directly at the bottom and set unit for optimum performance. Place the transducer in the test device as shown on the side bar. If the sonar performance is significantly degraded, another location will need to be tested.

Installing the Transducer

1. Lightly sand the surface of the hull and face of the transducer with 400 grit wet or dry sandpaper.
2. Build a dam using strip caulk about 1/4" tall. Pour about 1/8" of two part, slow cure epoxy in the dam. Place the transducer in the epoxy, turning the transducer to work out any air bubbles.
3. Weight the transducer in place and allow to cure for 24 hours.

-Fishfinder 240

Installation

Mounting the Transducer

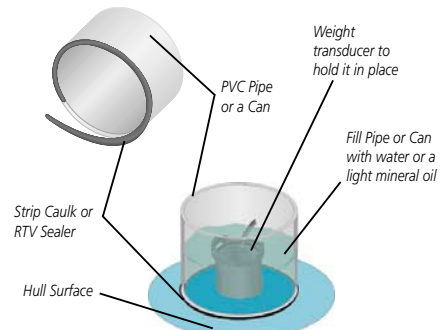

Testing the Location

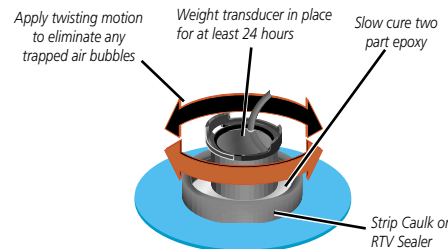

Installing the Transducer

Installation

Mounting the Transducer

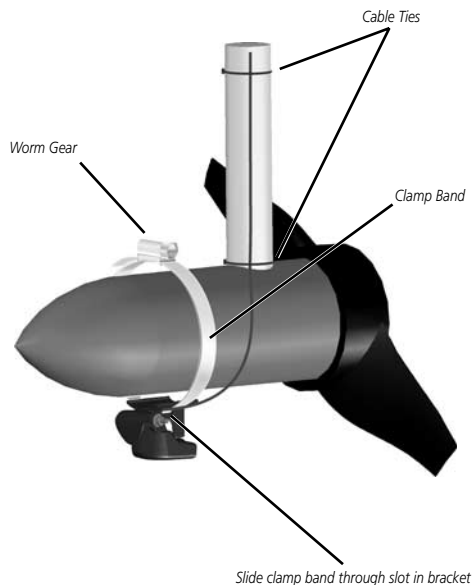

Trolling Motor Installation

Included in the 010-10251-00 transducer kit you should have:

- Worm Gear Clamp
- Cable Ties
- Transducer

Mounting the Transducer:

1. Loosen the Worm Gear Clamp until end of the band is clear of the worm gear.
2. Slide the clamp band through the slots on the transducer.
3. Place the free end of the clamp band into the worm gear and tighten until the band is through the worm gear.
4. Place the clamp and transducer over the body of the trolling motor. Finish tightening the clamp to secure the transducer to the trolling motor.
5. Secure the transducer cable to the trolling motor shaft using the supplied cable ties.



If you are experiencing interference while the trolling motor is operating, try installing the transducer cable at right angles to the trolling motor power cables.

Wiring Harness Installation

The Fishfinder 240 comes with a wiring harness that connects the unit to power and the transducer with one easy-to-remove connection. Make sure the wiring harness will reach the unit before beginning installation.

If it is necessary to extend the power/data wires, use a wire of comparable size and keep your extension as short as possible.

If the transducer lead is too short, DO NOT cut the transducer lead to lengthen the cable. This will void the warranty. Transducer extension cables are available in 10' or 20' lengths from your GARMIN dealer.

Wiring to a Fuse Block

If your boat has an electrical system, it may be possible to wire the unit directly to an unused holder on your current fuse block. If you are using the boat's fuse block, remove the in-line fuse holder supplied with the unit.

Installing the Wiring Harness:

1. Determine the polarity of the fuse holder using a Test Light or Volt Meter.
2. Install the Red (+) wire on the Positive Fuse Holder Terminal.
3. Install the Black (-) wire on the Negative Fuse Holder Terminal.
4. Install a 2 amp fuse in the Fuse Holder.



During a typical installation, only the Red and Black wires are used. The Blue wire supplies NMEA data, and doesn't have to be connected for normal operation of the unit. The Yellow (alarm) wire is not used, the Fishfinder 240 does not support external alarms.

Installing the Wiring Harness

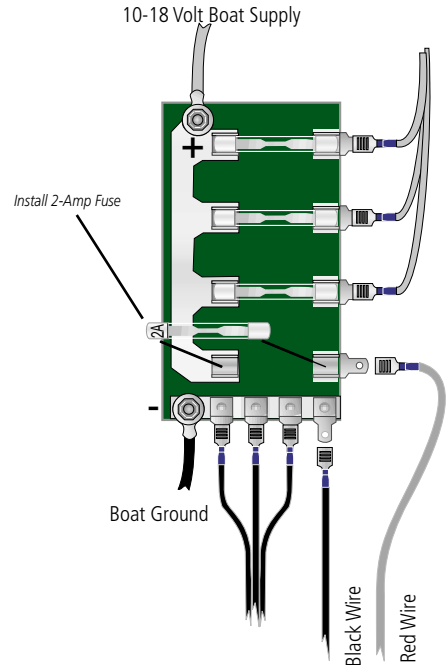

Fishfinder 240

-Fishfinder 240

Installation

Installing the Wiring Harness

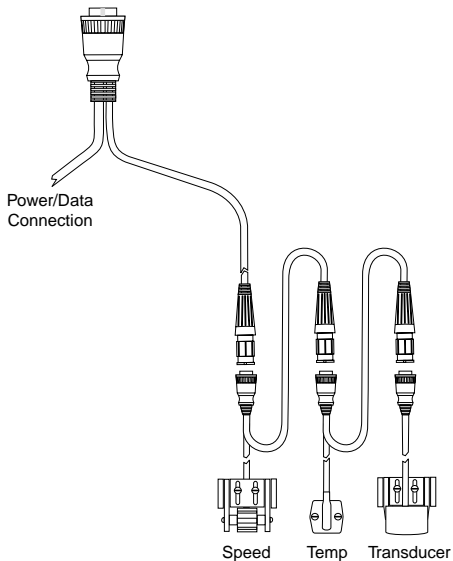

Connecting a Transducer to Multiple Sensors

Wiring Harness Installation (continued)

If your boat does not have a fuse block, the unit can be wired directly to the battery. Make sure the 2-Amp in-line fuse supplied with the unit is installed.

The Fishfinder 240 can be connected to another piece of NMEA compatible electronic equipment. If equipped with a capable transducer, the Fishfinder 240 sends depth, temperature and speed information that could be displayed on another device.

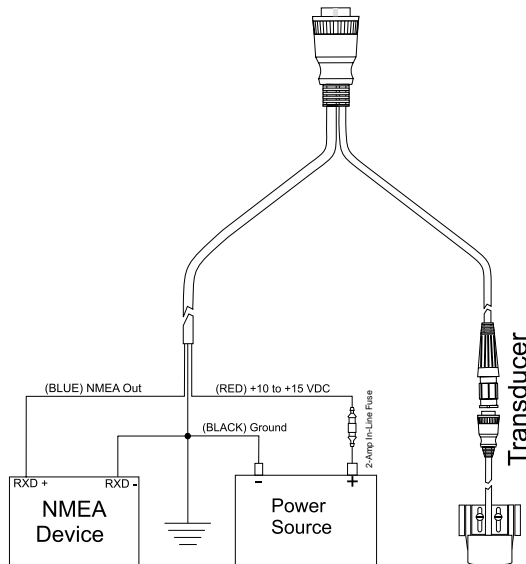

Display Installation (Surface Mount)

The Fishfinder 240 can be mounted to a flat surface using the supplied Surface Mounting Bracket.

Surface Mounting the Display:

1. Position the Surface Mount in the desired location. Leave approximately 2" behind the unit for cable clearance.
2. Mark the location of the four mounting holes with a pencil.
3. Drill pilot holes for the mounting fasteners (not included in kit).
4. Secure the Surface Mount, using the mounting fasteners.
5. Slip the unit into the surface mount bracket.
6. Tighten the knobs to secure the unit to the bracket.



The Surface Mount Bracket is designed to be secured using a flat head screw. If you use a screw with a countersunk head you risk damaging the Surface Mount Bracket.



-Fishfinder 240

Installation

Installing the Display

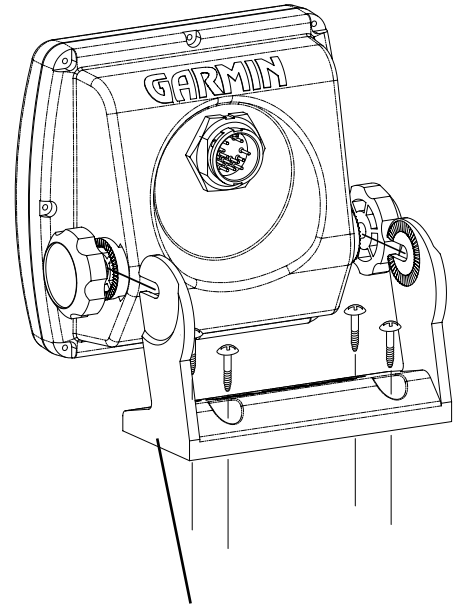

Surface Mount Bracket

Installation

Installing the Display

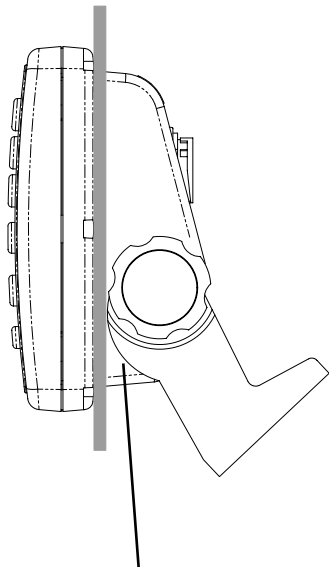

Pull bracket down until cam lobe contacts

Display Installation (Flush Mount)

The Fishfinder 240 can be mounted flush against a dash or electronics rack that is no more than 1/4" thick.

Flush Mounting the Display:

1. Remove the Surface Mount Bracket and Knobs.
2. Cut a 4.3" W x 4.35" H relief hole where the unit will be mounted.
3. Place the display in the relief hole and tape in place.
4. Reinstall the knobs in the unit. Install the surface mount with the cam lobes pointed toward the unit.
5. Rotate the surface mounting bracket forcing the cam lobes to pull the unit tight against the surface. Tighten the knobs.

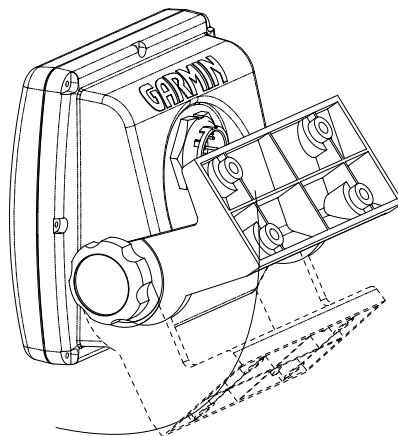

Testing the Installation**Testing the Installation**

While it is possible to perform some checks with the boat trailered, to properly test the installation the boat should be in the water.

Press the **Power** button and the Fishfinder 240 should power on. If the unit fails to power on, verify that the wiring adapter is seated properly in the back of the unit, the Red and Black wires are connected to the correct polarity, and that the 2-Amp fuse is installed and not blown. If the unit is connected to a power supply that exceeds 18 VDC, a 'Battery Voltage High' warning will be displayed and the unit will turn off.

As the unit powers on, it should immediately start showing the bottom. Verify that the unit is not in the simulator mode. If the unit is in the simulator mode, make sure that the transducer is connected to the wiring harness.

To test the transducer installation, gradually increase the boat speed while checking the unit operation. If the unit displays intermittently or fails to display, verify that the transducer is aligned parallel with the bottom and if necessary, adjust the transducer height until the unit operates correctly. It may be necessary to make several adjustments to ensure proper operation throughout the speed range.



When adjusting the depth of the transducer, make the adjustments in small increments. Placing the transducer too deep can adversely affect the boat's performance and place the transducer at greater risk of striking underwater objects.

Unit Operation

Keypad Function



Arrow Keys

The **Arrow** Keys are used to select items on the Adjustment Bar and Setup menu and to change field data.

Enter Key

The **Enter** key is used to activate/deactivate Adjustment Bar and Setup Menu data fields for review or change

Setup Key

The **Setup** key is used to activate/deactivate Setup Menu.

Power Key

The **Power** Key is used to turn the unit on/off and to activate the display backlight. Press and hold to turn the unit off. Press briefly and release to activate the backlight

At the top left of the display you will find the Adjustment Bar and a variety of user-selectable information including Depth, Battery Voltage, Water Temperature, and Speed Over Water. To provide data on Water Temperature and Speed Over Water, the Fishfinder 240 requires additional sensors capable of producing the particular data.

The Depth Scale and the Flasher Function are displayed from top to bottom along the right side of the display. Messages and Alarm Icons are displayed along the bottom.

The Fishfinder 240 has three levels of display backlighting, Off, Low and High. The backlight is activated by momentarily pressing the **Power** key. To change the backlight level, press the **Power** key repeatedly.



If the unit is unable to track the bottom for any reason, the digits in the depth window will flash on and off to alert the user that the unit is not tracking the bottom.

Describing The Display

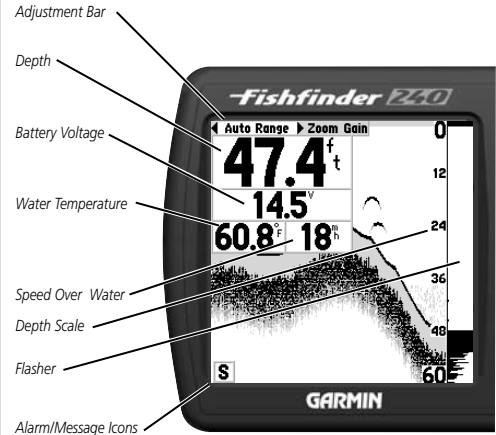

Unit Operation

The Adjustment Bar

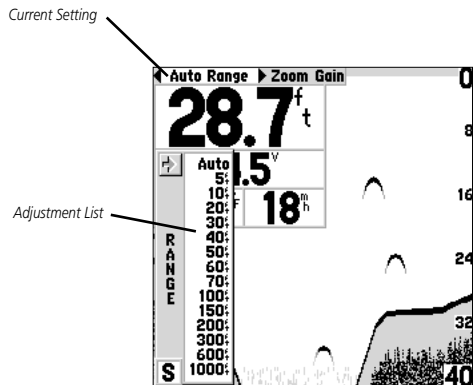

Using the Adjustment Bar

The Adjustment Bar allows direct access to the settings most commonly changed while using the unit. These include the depth Range, Zoom setting, and the Gain (sensitivity) of the unit.

Place the highlight (white bar) over the desired selection using the **RIGHT** or **LEFT** Arrow key and the current setting will be displayed in the highlight. To immediately change the setting, press the **UP** or **DOWN** Arrow key. If you wish to review the available settings before making a change, press the **ENTER** key to activate the adjustment list.

Range

The Range Adjustment is used to set the display depth range. The unit can be set to automatically track the bottom or set to a user-specified range.

To select a Range:

1. Highlight 'Range' on the Adjustment Bar.
2. Using the **UP** or **DOWN** Arrow, place the pointer at the desired range.

Setting the unit to automatically track the bottom:

1. Highlight 'Range' on the Adjustment Bar.
2. Using the **UP** or **DOWN** Arrow, select 'Auto' at the top of the adjustment list

Unit Operation

Zoom

The Zoom Adjustment is used to quickly select a display zoom scale.

To change the zoom scale:

1. Highlight 'Zoom' on the Adjustment Bar.
2. Using the **UP** or **DOWN** Arrow, select the desired display zoom level.

When a scale other than 'No Zoom' is selected, the Adjustment Bar will display a new selection labeled View.

View

The View Adjustment is available only when a Zoom Scale other than 'No Zoom' is selected. This setting allows you to select a specific area to view on the display or allow the unit to automatically select a viewing area based on the bottom.

To change the view:

1. Highlight 'View' on the Adjustment Bar.
2. Press the **UP** or **DOWN** arrows to change the setting.

To have the unit automatically set a view:

1. Highlight 'View' on the Adjustment Bar
2. Using the **UP** or **DOWN** Arrow, move the slider to the top or bottom of the range then release and press the Arrow again.

The Adjustment Bar

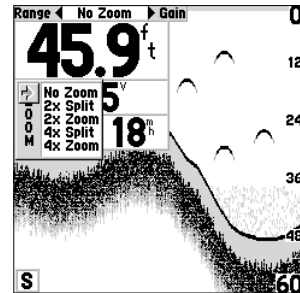

Zoom Adjustment

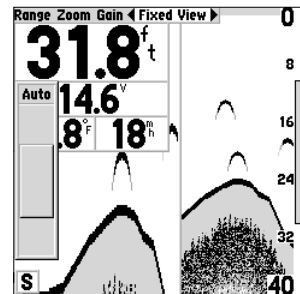

View Adjustment

Unit Operation

The Adjustment Bar

Gain

The Gain Adjustment allows the user to control the sensitivity of the unit's receiver. This provides some flexibility in what is seen on the display. To see more detail, increase the receiver sensitivity by selecting a higher gain (+). If there is too much detail or if the screen is cluttered, lowering the sensitivity (-) may increase the clarity of the display.

To change the Gain:

1. Highlight 'Gain' on the Adjustment Bar.
2. Using the **UP** or **DOWN** Arrows, move the pointer to the desired setting.

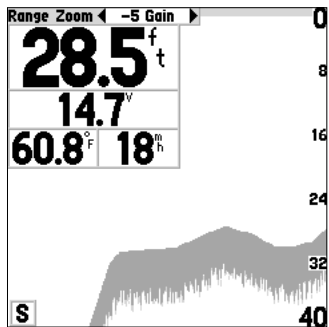

Minimum Gain

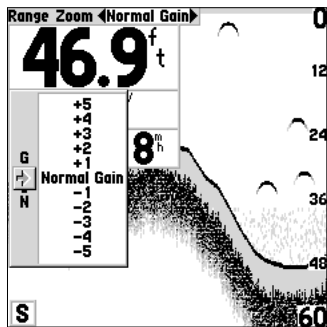

Normal Gain

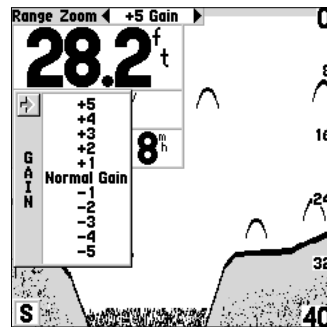

Maximum Gain

Setup Menu

The Setup Menu contains the unit settings that should not require frequent change. The Setup Menu is divided into eight tabs: Chart, Tools, Numbers, Alarms, System, Calibrations, Units, and Memory. Each tab will be described in more detail in this section.

To enter and exit the Setup Menu, press the **SETUP** button on the face of the unit. The first time that the **SETUP** button is pressed, the Setup Menu will be displayed with the 'Chart' tab highlighted in black. Pressing the **UP** or **DOWN** arrow will move the highlight between the tab selections. Press the **RIGHT** arrow to access the selection fields. Each time the Setup Menu is accessed, the unit will return to the last edited selection field. Press the **LEFT** arrow key to get back to the tabs.

Chart

The 'Chart' tab allows the user to determine the appearance of the scrolling chart display. To access the 'Chart' tab place the highlight over it using the arrow keys.

Fish Symbols

'Fish Symbols' allows the user to determine how the chart will display underwater targets and background information. If 'Fish Symbols' are set to 'OFF', the unit will display all of the available information about the underwater environment. If a fish symbol is selected, the chart will display only the information related to that symbol.

To select a Fish Symbol:

1. Highlight the 'Chart' tab on the Setup Menu.
2. Highlight the 'Fish Symbol' selection field and press **ENTER**.
3. Using the **UP** or **DOWN** arrow select the desired symbol and press **ENTER**.

Setup Menu/Chart

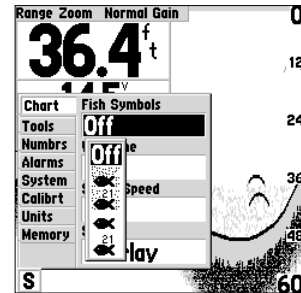

Fish Symbols



— All available information will be displayed.



— Suspended targets will display as symbols. In this mode background information will still be displayed making fish identification easier.



— Same as above with target depth displayed.



— Suspended targets displayed as symbols. No background information will be displayed in this mode.



— Same as above with target depth displayed.

Unit Operation

Setup Menu/Chart

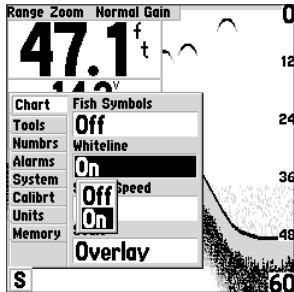

Whiteline Selections

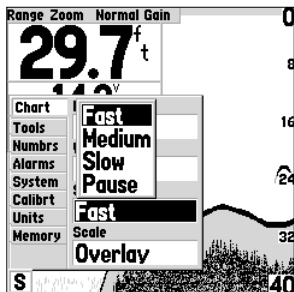

Scroll Speed Selections

Whiteline

'Whiteline' controls how the unit displays information about the bottom type (hard or soft). With the Whiteline 'OFF', the bottom return will display as black and contain no information on bottom hardness. With Whiteline 'ON', the bottom return will become gray scaled and can be used to determine bottom hardness. See page 31 for more detail on this feature.

To Change the Whiteline Setting:

1. Highlight the 'Chart' tab on the Setup Menu.
2. Highlight the 'Whiteline' selection field and press **ENTER**.
3. Choose 'ON' or 'OFF' and press **ENTER** to accept the selection.

Scroll Speed

The speed that the chart scrolls from right to left can be adjusted using the 'Scroll Speed' selection field. If you are sitting still, or the chart is moving too fast slowing the scroll rate can be beneficial.

To Adjust the Scroll Speed:

1. Highlight the 'Chart' tab on the Setup Menu.
2. Highlight the 'Scroll Speed' selection field and press **ENTER**.
3. Choose 'Fast', 'Medium', 'Slow' or 'Pause', press **ENTER** to accept the selection.



If you are using the Fishfinder 240 on the portable case battery power, slowing the scroll rate will help to conserve your battery.

Scale

The depth 'Scale' is displayed vertically along the right side of the chart. The depth 'Scale' can be configured to display four different ways: as an 'Overlay', in the 'Corners', with 'Basic' or 'No Scale'.

To Change the Scale Setting:

1. Highlight the 'Chart' tab on the Setup Menu.
2. Highlight the 'Scale' selection field and press **ENTER**.
3. Choose 'Overlay', 'Corners', 'Basic' or 'No Scale', press **ENTER** to accept the selection.

Setup Menu/Chart

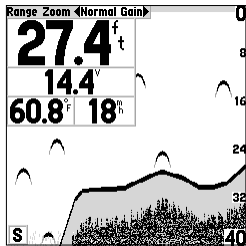

Scale — *Overlay*

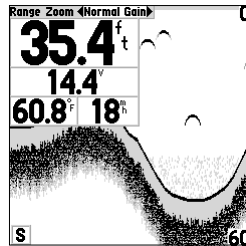

Scale — *Corners*

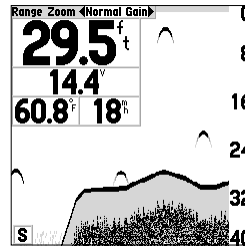

Scale — *Basic*

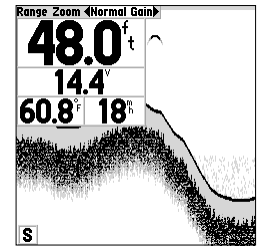

Scale — *No Scale*

Unit Operation

Setup Menu/Tools

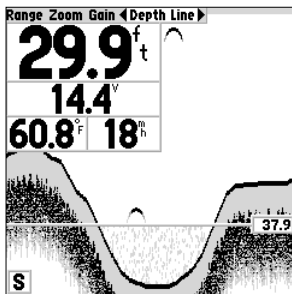

Depth Line

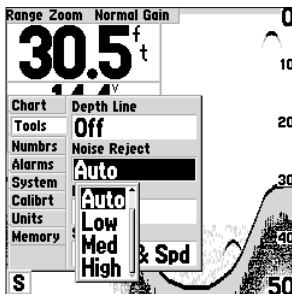

Noise Reject Selections

Tools

The Tools tab contains the 'Depth Line', 'Noise Reject', 'Flasher', and 'Simulator' tools. The 'Depth Line' tool is used to quickly identify a set depth or measure the depth of underwater objects. The 'Noise Reject' and 'Flasher' tools are used to enhance the chart and help in identifying and providing information about an underwater return. The 'Simulator' tool is used to enhance the simulator mode by allowing you customize the simulated transducer selection. To access the Tools tab place the highlight over it using the arrow keys.

Depth Line

When the 'Depth Line' tool is activated, a Depth Line selection is added to the Adjustment Bar.

To Activate the Depth Line:

1. Highlight the 'Tools' tab on the Setup Menu.
2. Highlight the 'Depth Line' selection field and press **ENTER**.
3. Select 'On' and press **ENTER**.

To Change the Depth Line Setting:

1. Place the highlight over the Depth Line selection on the Adjustment Bar.
2. Use the **UP** or **DOWN** arrow to change the setting.

Noise Reject

The 'Noise Reject' tool helps filter unwanted noise from the chart. The 'Noise Reject' tool can be turned 'OFF', set to 'AUTO'(automatically) adjust or to a fixed 'LOW', 'MED'ium or 'HIGH' setting.



Remember when setting the Noise Reject tool, the higher the noise rejection setting, the more likely the unit is to not show fish or structure.

To Change the Noise Reject Setting:

1. Highlight the 'Tools' tab on the Setup Menu.
2. Highlight the 'Noise Reject' selection field and press **ENTER**.
3. Choose 'Off', 'Auto', 'Low', 'Med', or 'High', and press **ENTER**.

Flasher

With the 'Flasher' tool active, a graphic Flasher representation will be displayed on the right side of the chart. This graphic Flasher displays structure and bottom returns much the same as a true Flasher. You may find this feature particularly useful when using 'Fish Symbols'.

To Turn the Graphic Flasher On and Off:

1. Highlight the 'Tools' tab on the Setup Menu
2. Highlight the 'Flasher' selection field and press **ENTER**.
3. Select 'ON' or 'OFF' and press **ENTER** to accept the selection.

Simulator

The 'Simulator' tool allows you to select a transducer type for use with the Fishfinder 240's built in simulator. These choices allow the simulator to more accurately depict actual operation of the unit. For details on using the simulator see page 33.

Setup Menu/Tools

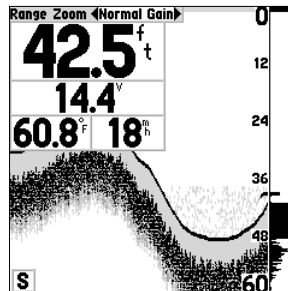

Graphic Flasher Selections

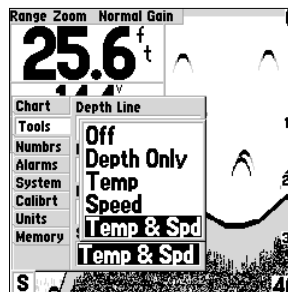

Simulator Selections

Unit Operation

Setup Menu/Numbers

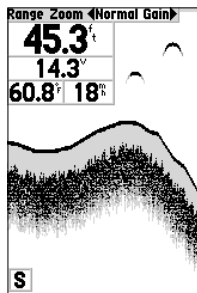

Normal Numbers

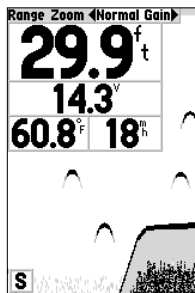

Large Numbers

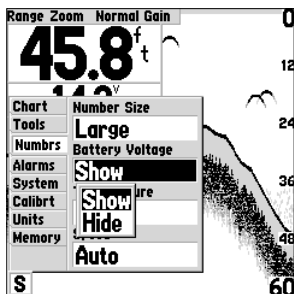

Battery Voltage Selections

Numbers

The 'NUM' (Numbers) tab allows you to choose whether you would like to see normal or large numbers on the chart. You can also configure the unit to display 'Battery Voltage', (water) 'Temperature', and 'Speed' Over Water if the unit is equipped with a capable transducer. To access the Numbers tab place the highlight over it using the arrow keys.

Number Size

This setting determines the size of the numbers displayed in the 'Depth', 'Temperature', 'Battery Voltage' and 'Speed' fields on the chart.

To Select Normal or Large Numbers:

1. Highlight the 'NUM' tab on the Setup Menu.
2. Highlight the 'Number Size' selection field and press **ENTER**.
3. Choose 'Normal' or 'Large', press **ENTER** to accept the selection.

Battery Voltage

The Fishfinder 240 can display the current battery voltage on the chart.

To Show or Hide the Battery Voltage Display Field:

1. Highlight the 'NUM' tab on the Setup Menu.
2. Highlight the 'Battery Voltage' selection field and press **ENTER**.
3. Choose 'Show' or 'Hide', press **ENTER** to accept the selection.

Unit Operation

Temperature

The Fishfinder 240 can display the water temperature when equipped with a temperature sensing transducer. The unit has the ability to automatically sense when a temperature capable transducer is connected and display the water temperature. The temperature field can be shown or hidden regardless of the transducer installed.

To Set the Temperature Display Field:

1. Highlight the 'NUM' tab on the Setup Menu.
2. Highlight the 'Temperature' selection field and press **ENTER**.
3. Choose 'Auto', 'Show' or 'Hide', press **ENTER** to accept the selection.

Speed

The Fishfinder 240 can display the boat's 'Speed' Over Water when equipped with a speed capable transducer or Speed Sensor. When set to 'AUTO' the unit will automatically sense when a capable transducer or sensor is connected and display the Speed.

To Set the Speed Display Field:

1. Highlight the 'NUM' tab on the Setup Menu.
2. Highlight the 'Speed' selection field and press **ENTER**.
3. Choose 'Auto', 'Show' or 'Hide', press **ENTER** to accept the selection.

Setup Menu/Numbers

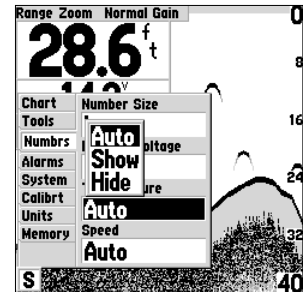

Temperature Display Selections

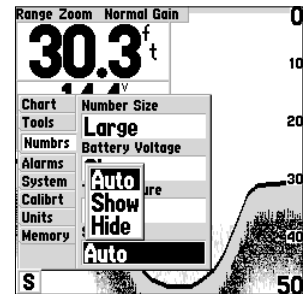

Speed Display Selections

Unit Operation

Setup Menu/Alarms

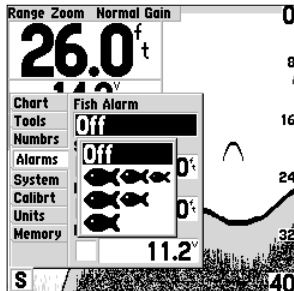

Fish Alarm Selections

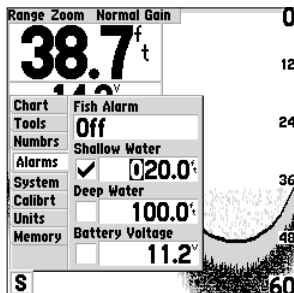

Shallow Water Alarm

Alarms

The 'Alarm' tab allows you to activate and configure the four alarms available in the Fishfinder 240. To access the 'Alarm' tab place the highlight over it using the arrow keys. See page 35 for alarm icons and messages.

Fish Alarm

The 'Fish Alarm' can be configured to sound by fish size. There are four different alarm selections: 'Off', 'Small, Medium and Large', 'Medium and Large', or 'Large'.

To Select an Alarm:

1. Highlight the 'Alarm' tab on the Setup Menu.
2. Highlight the 'Fish Alarm' selection field and press **ENTER**.
3. Choose the desired setting, press **ENTER** to accept the selection.

Shallow Water

The 'Shallow Water' Alarm can be set to sound a warning at a depth determined by the user. Before the unit will sound a warning the alarm must be activated.

Activating/Deactivating the Shallow Water Alarm:

1. Highlight the 'Alarm' tab on the Setup Menu.
2. Highlight the 'Shallow Water' checkbox.
3. Pressing **ENTER** will insert or remove a check mark in the checkbox.

Setting the Shallow Water Alarm Depth:

1. Highlight the 'Shallow Water' Depth Field and press **ENTER**.
2. Using the arrow keys input the desired depth, press **ENTER** to accept the setting.

Unit Operation

Deep Water

The 'Deep Water' Alarm can be set to sound a warning at a depth determined by the user. Before the unit will sound a warning the alarm must be activated.

Activating/Deactivating the Deep Water Alarm:

1. Highlight the 'Alarm' tab on the Setup Menu.
2. Highlight the 'Deep Water' checkbox.
3. Pressing **ENTER** will insert or remove a check mark in the checkbox.

Setting the Deep Water Alarm Depth:

1. Highlight the 'Deep Water' Depth Field and press **ENTER**.
2. Using the arrow keys input the desired depth, press **ENTER** to accept the setting.

Battery Voltage

The 'Battery Voltage' alarm can be set to warn you when the battery is reaching a critical state of discharge.

Activating/Deactivating the Deep Water Alarm:

1. Highlight the 'Alarm' tab on the Setup Menu.
2. Highlight the 'Battery Volts' checkbox.
3. Pressing **ENTER** will insert or remove a check mark in the checkbox.

Setting the Battery Volts Alarm:

1. Highlight the 'Battery Volts' field and press **ENTER**.
2. Using the arrow keys input the desired voltage, press **ENTER** to accept the setting.

Setup Menu/Alarms

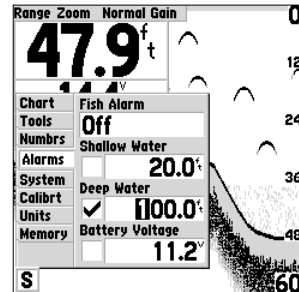

Deep Water Alarm

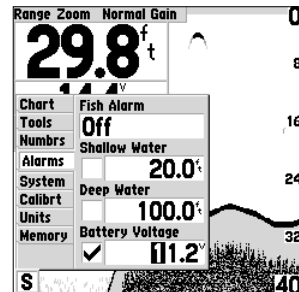

Battery Voltage Alarm

Unit Operation

Setup Menu/Alarms

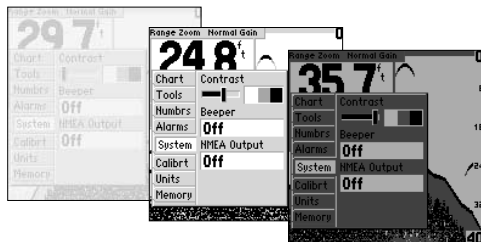

Contrast Adjustment

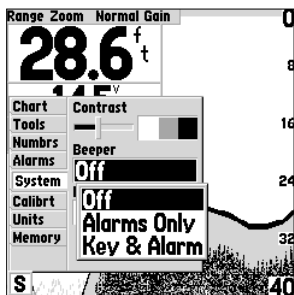

Beeper Selections

System

The 'Sys'(System) tab contains the 'Contrast', 'Beeper', and 'NMEA' Output setups. To access the 'System' Setup Menu, use the arrow keys to highlight the System tab.

Contrast

The display 'Contrast' may need to be adjusted to compensate for light levels or viewing angles.

To Adjust the Contrast:

1. Highlight the 'System' tab on the Setup Menu.
2. Highlight the 'Contrast' Adjustment field and press **ENTER**.
3. Move the slider using the arrow keys, press **ENTER** to accept the setting.

Beeper

The 'Beeper' field contains three settings: 'Off', 'Alarms Only', and 'Key & Alarm'.

To Change the Beeper Setting:

1. Highlight the 'System' tab on the Setup Menu.
2. Highlight the 'Beeper' field and press **ENTER**.
3. Choose 'Off', 'Alarms', or 'Key & Alarms', press **ENTER** to accept the setting.

NMEA Output

The Fishfinder 240 has the ability to output information about Depth, Speed, and Water Temp for display on another NMEA-compatible device.

To Activate/Deactivate the NMEA Output:

1. Highlight the 'System' tab on the Setup Menu.
2. Highlight the 'NMEA' Output field and press **ENTER**.
3. Choose 'Off', or 'On', press **ENTER** to accept the setting.

Calibration

Keel Offset

The 'Keel Offset' field allows the user to offset the depth reading for a keel or for the draw on a larger vessel .

To Set a Keel Offset:

1. Highlight the 'Calibration' tab on the Setup Menu.
2. Highlight the 'Keel Offset' field and press **ENTER**.
3. Using the arrow keys enter a new offset, press **ENTER** to accept.

Water Type

Since sound waves travel through fresh and salt water at different rates, it is necessary to select the 'Water Type' to ensure accurate depth readings.

To Change the Water Type:

1. Highlight the 'Calibration' tab on the Setup Menu.
2. Highlight the 'Water Type' selection field and press **ENTER**.
3. Choose 'Fresh' or 'Salt', press **ENTER** to accept the selection.

Speed Sensor

With a speed sensor installed, the 'Calibrate Speed' field will become available. This will allow you to calibrate the Fishfinder speed to your boats speedometer or your GPS speed.

To Calibrate the Speed:

1. Highlight the 'Calibration' tab on the Setup Menu.
2. Highlight the 'Calibrate Speed' button and press **ENTER**.
3. Run your boat, noting your top speed. Stop the boat and press **ENTER**.
4. With the speed field highlighted, press **ENTER** and input your top speed. Highlight 'OK' and press **ENTER** to finish the calibration.

Setup Menu/Calibrations

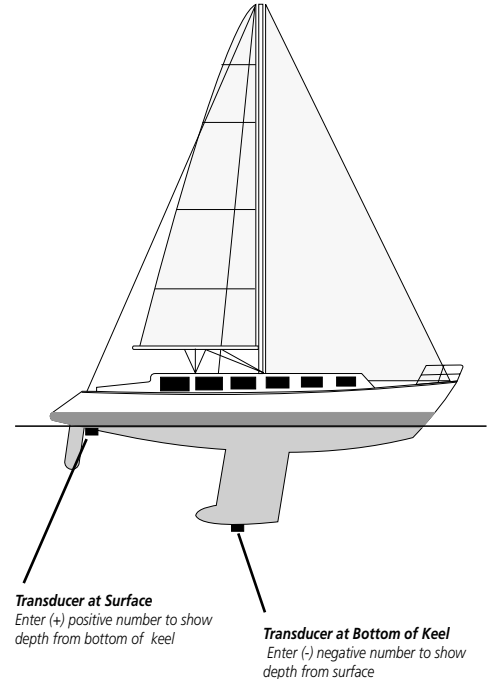

Unit Operation

Setup Menu/Units

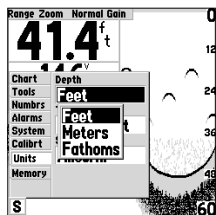

Depth Selections

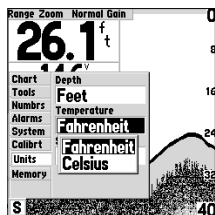

Temperature Selections

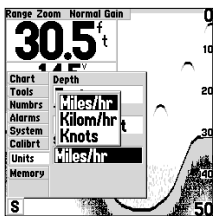

Speed Selections

Units

The 'Units' tab contains settings for 'Depth', 'Temperature' and 'Speed'. To access the 'Units' tab, use the arrow keys to highlight it.

Depth

The 'Depth' field can be configured to display in Feet (ft), Meters (mt) or Fathoms (fa).

To Select a Depth Unit:

1. Highlight the 'Units' tab on the Setup Menu.
2. Highlight the 'Depth' field and press **ENTER**.
3. Select 'Feet', 'Meters', or 'Fathoms', press **ENTER** to accept the new setting.

Temperature

If equipped with a temperature capable transducer, the unit can display water temperature in Fahrenheit (°F) or Celsius (°C).

To Select a Temperature Unit,

1. Highlight the 'Units' tab on the Setup Menu.
2. Highlight the 'Temperature' field and press **ENTER**.
3. Select 'Fahrenheit' or 'Celsius' press **ENTER** to accept the new setting.

Speed

If equipped with a speed capable transducer, the unit can display the boat's 'Speed' Over Water. The unit can be configured to display in 'Nautical Miles-Per-Hour' (kt), 'Kilometers-Per-Hour' (kh), or 'Miles-Per-Hour' (mh).

To Select a Speed Unit:

1. Highlight the 'Units' tab on the Setup Menu.
2. Highlight the 'Speed' field and press **ENTER**.
3. Select 'Miles', 'Kilometers', or 'Knots', press **ENTER** to accept the

Memory

The 'Memory' tab contains the settings for unit memory, allows you to reset the unit to the factory setup and allows you to review software version information. To access the 'Memory' tab, use the arrow keys to highlight it.

Remember

The Fishfinder 240 can be set to remember All of the unit settings including the Adjustment Bar or the items in Setup Only.

To Select a Memory Setting:

1. Highlight the 'Memory' tab on the Setup Menu.
2. Highlight the 'Remember' field and press **ENTER**.
3. Choose 'All' or 'Setup Only', press **ENTER** to accept the selection.

Factory Setup

To Restore the Factory Settings:

1. Highlight the 'Memory' tab on the Setup Menu.
2. Highlight the 'Factory' Setup button and press **ENTER**.
3. Choose 'OK' to reset the unit or 'Cancel' to abort.

Software Version

The 'Software Version' Button will report information about the current software version in the unit, and display the ID Number.

To Activate the Software Version Window:

1. Highlight the 'Memory' tab on the Setup Menu.
2. Highlight the 'Software Version' button and press **ENTER**.
3. Press **ENTER** to close the information window.

Setup Menu/Memory

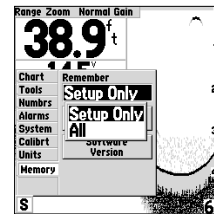

Remember Selections

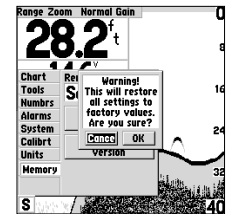

Reset to Factory Settings

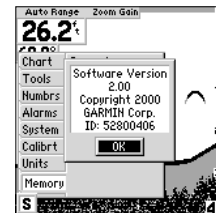

Software Version Information

Unit Operation and the Chart

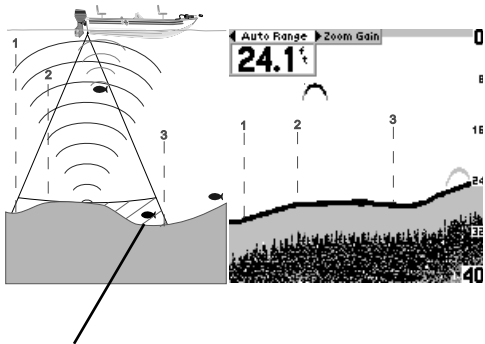

This fish is currently in a Dead Zone and is not detected by the sonar. The fish is in the coverage area of the transducer, but remember the first strong return sets the bottom level. The fish will never be detected since the bottom level will never be set below the fish. The fish on the right side of the display (shown in light grey) will be detected and displayed when the transducer cone passes over the fish.

Understanding Sonar

If you are familiar with sonar, and can determine what is on the chart, this section may not be for you. This section is intended to help the novice user gain some understanding of how the Fishfinder 240 operates and how it can help improve their fishing productivity.

To understand what the unit is displaying, it is important to have a general knowledge of how the unit works and how it determines what to display. Briefly described, the unit operates by transmitting sound waves toward the bottom of a lake, stream or seabed in a cone shaped pattern. When a transmitted soundwave strikes an underwater object such as the bottom, a piece of structure, or a fish, sound is reflected back to the transducer. The transducer collects the reflected sound waves and sends the data to the unit to be processed and displayed on the chart. The underwater data is displayed on the chart in the order that it is returned: first returned—first on the chart. The diagram in the sidebar demonstrates this showing an underwater scene as it would be displayed on the chart. Generally speaking, if the only thing between the transducer and the bottom is water, the first strong return will come from the bottom directly below the transducer. The first strong return sets the bottom level. Weaker secondary returns provide the detailed data. Stronger returns will display in darker colors, black being the strongest return. In Example 2 (page 30) you can see that the branches and the fish were the strongest secondary returns and are indicated in black on the display.

That is brief description of how your Fishfinder operates. Let's take a look at how this data can help you to improve your fishing.

Transducer Coverage

The area covered by the transmitted sound waves is determined by the cone angle of the transducer and the water depth. Using Garmin's standard 20° transducer, the coverage is approximately 1/3rd of the water depth. As shown in Example 1, the coverage area at a 30 foot depth is approximately a 10 foot diameter circle. The scale below illustrates how coverage increases as depth increases.

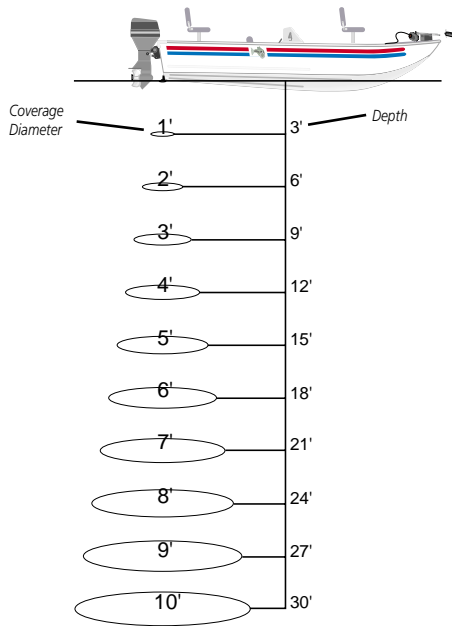

Example 1.

-Fishfinder 240

On the Water

Transducer Coverage

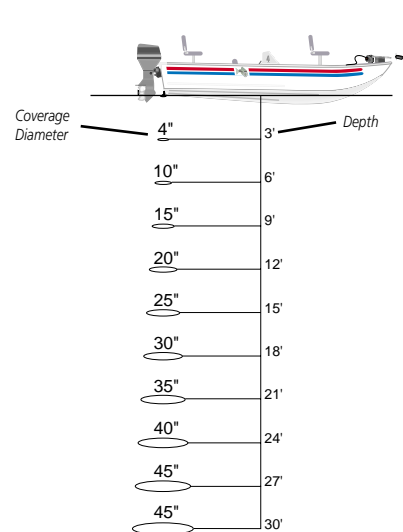

8° Transducer Coverage Chart

Understanding the Chart

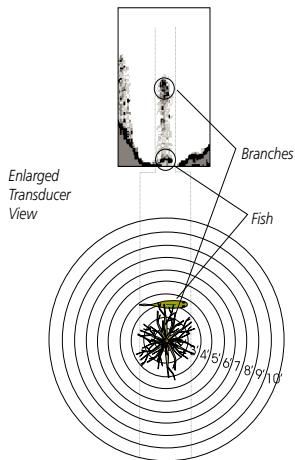

Remember that the Fishfinder displays a 2D picture of the underwater environment. The fish and tree could be located anywhere in the coverage area at that slice of time.

Understanding the Chart

It is important to understand that the unit does not display a 3-D representation of the underwater environment. The unit can display multiple things at the same time, but can not determine where the return originated only when it was received.

Example 2 provides a look at the underwater world from a top view, and relates that view to what would be displayed on the chart. On the chart it appears the fish and tree are side by side, but when we look at the scene from the top we can see that the fish is several feet from the tree. It is important to remember that the fishfinder can not determine where in the coverage area the tree or fish are, only that the returns were received in the same time frame.

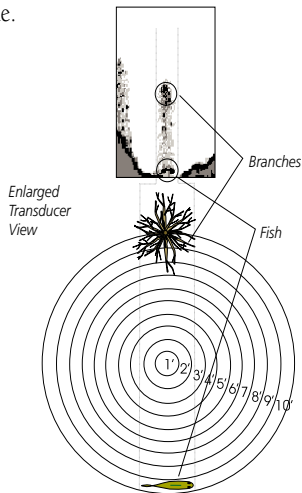

Example 2.

Whiteline

The Fishfinder 240 can help you to determine if the bottom is hard or soft. When the sonar soundwaves are reflected back by the bottom, a hard bottom will return a stronger signal than a soft bottom. The stronger bottom return, the wider the bottom layer is displayed. The unit uses the whiteline function to make this bottom layer information easier to distinguish.

When viewing the display without Whiteline active, the bottom return is black. While you can make some determination of the bottom type, the black return makes this more difficult. With the whiteline active the bottom return appears layered in shades of gray and black and makes determining the bottom type easier and more reliable. Example 3 shows the bottom return with and without the whiteline activated.

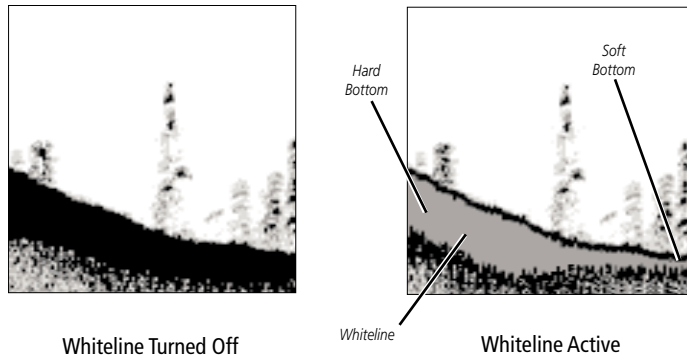

Example 3.

Understanding the Chart



Whiteline can also help you to determine the type of bottom structure that is displayed on chart. By determining the hardness of the structure you can make a better informed decision on the type of structure.

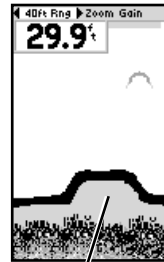

Structure is hard, probably a rock or stump



Structure is soft, probably a mud pile

Understanding the Chart

Thermoclines

One of the unique features offered by GARMIN is See-Thru® technology. See-Thru® technology allows the Fishfinder 240 to see through thermoclines and helps locate fish where they live, and fish love the thermocline.



A rough definition of a thermocline is a break in water where the water temperature changes faster than the water above it. The thermocline usually displays as a gray level as shown below.

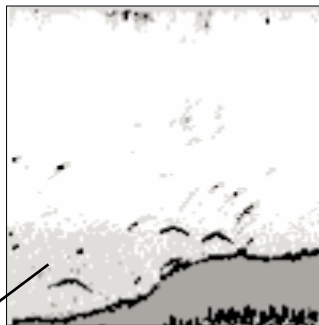

Thermocline

Simulator Mode

The Fishfinder 240 comes with a built-in simulator mode that will allow the user to practice and learn the operation of the unit at home rather than on the water.

To start the simulator mode, turn the unit on without a transducer installed. As the unit powers on, the unit will indicate that it is running the simulator mode by displaying a message across the bottom of the chart. The message will be replaced by the simulator mode icon in the lower left corner of the chart. While in the simulator mode, the unit will display a random bottom scene and the Fishfinder 240 can be controlled just as if it were on the water.

The unit can be configured to act as if a variety of transducers are installed while in the simulator mode.

To Select a Specific Transducer:

1. Press the **Setup** button on the face of the unit.
2. Using the arrow keys, highlight the 'Tools' tab then the 'Simulator' selection field.
3. Press **ENTER**. Choose the desired transducer from the list.
4. Press **ENTER** to accept the transducer selection.

To exit the Simulator, turn the unit off.

Simulator Mode

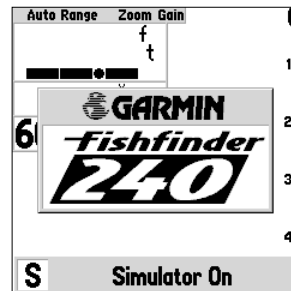

Simulator Message and Icon

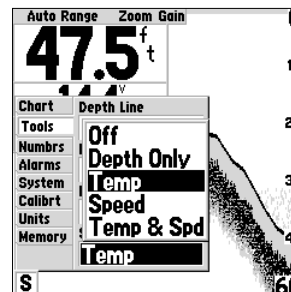

Simulator Transducer Selections

Appendix A

Specifications

Physical

Case: Fully Gasketed, high-impact plastic alloy

Display: 3.3" x 3.3" (8.3 x 5 cm) 240 H x 240 W pixels

Size: 4.625" H x 6.0" W x 2.75" D (11.7 x 15.2 x 7cm)

Weight: 24 oz.

Temperature Range: +5° to 158°F (-15C to 70C)

Waterproof: IEC 529, level IPX-7 (submerged to 1 meter for 30 minutes)

Power

Input: 10 to 18 VDC with High Voltage Protect

Usage: 10 watts maximum

Nominal: 12 VDC @ 0.8 amps

Performance

Sonar Power Output: 400 watts (RMS), 3200 watts (peak to peak)

Frequency: 200 kHz

Depth 1200 foot max depth*

NMEA

Support: NMEA 0183 Versions 2.0 - 2.3

Output Sentences: DBT, DPT, MTW, VHW

* Depth capacity is dependent on water salinity, bottom type and other water conditions.

Specifications subject to change without notice.

Messages and Alarms

Alarm Messages and Icons

The Fishfinder 240 displays a message when an alarm is tripped. To clear the message press the **ENTER** key. If the **ENTER** key is not pressed, the unit will automatically remove most messages after 10 seconds and display a reminder icon in the lower left corner of the chart until the alarm is no longer valid.

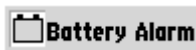

Battery Voltage Low



Deep Water Alarm



Shallow Water Alarm



Supply Voltage Low



Supply Voltage High



Unit Needs Repair



Unit Needs Repair

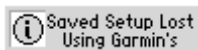

Memory Deleted

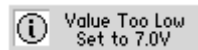

Increase Setting



Fish Alarm

Fishfinder 240 Portable

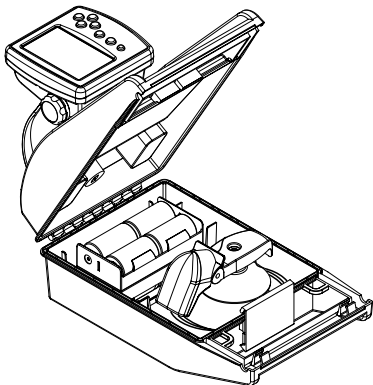

Secure Fishfinder 240 to the boat using the provided eyelets

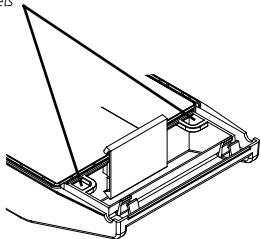

Fishfinder 240 Portable

The Portable Case

The Portable Case is designed for rugged use and provides storage for the Battery Pack and the Portable Suction Cup Transducer and a mount for the Fishfinder 240. The case is water resistant but is not designed to float in the event it should go overboard.



Use the two square eyelets located by the handle to secure the Fishfinder 240 Portable Case to the boat.

The Suction Cup Transducer

Using the Portable unit you will still need to find a suitable location for the transducer. If you are in a slow moving boat such as a canoe or flat bottom boat, the mounting location is not as critical. Follow these simple guidelines and you should be fine.

1. Look for clean (non-turbulent) water
2. Mount the transducer with approximately 1/2" extending beyond the bottom of the boat.
3. Do not mount the transducer behind strakes on the bottom of the boat or in the path of a prop.
4. If you experience poor reception, try another location.



WARNING! Speeds in excess of 20 MPH may cause the transducer to fly off and strike occupants of the boat.

When storing the Suction Cup Transducer in the case, dry the transducer and cable to avoid corrosion. If using in Salt Water, rinse the transducer and cable in fresh water and dry before storing in the case.

Batteries

The Fishfinder 240 Portable comes with a D-Cell battery pack. Eight D-Cell Alkaline batteries will provide approximately 20 hours of continuous operation. You have the option of purchasing a 12 Volt Rechargeable Gel-Cell Battery for the portable case. If using a Gel-Cell battery you can anticipate approximately 40 hours of continuous operation between charges. Cold temperatures reduce battery life.

Installing the D-Cell Batteries:

1. Disconnect the Red and Black leads.
2. Install the batteries noting the correct polarity.
3. Reconnect the Red and Black leads and place the battery pack (batteries down) in the provide location within the case.

Installing a Gel Cell Battery:

Verify that the Gel-Cell battery has male spade connectors installed on the positive and negative leads.

1. Disconnect the Red and Black leads and remove the D-Cell Battery Pack.
2. Connect the Red and Black Gel-Cell leads to the Red and Black wires in the portable case.
3. Place the Gel-Cell battery in the same location as the D-Cell Battery Pack. The Portable Case was designed to accommodate a 12 Volt

Fishfinder 240 Portable

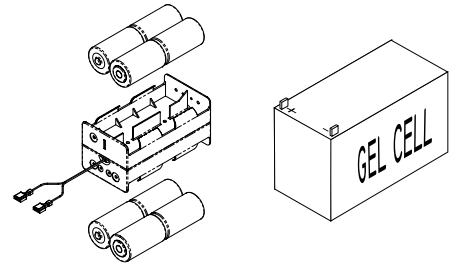

D-Cell and Optional Gel-Cell Battery Packs

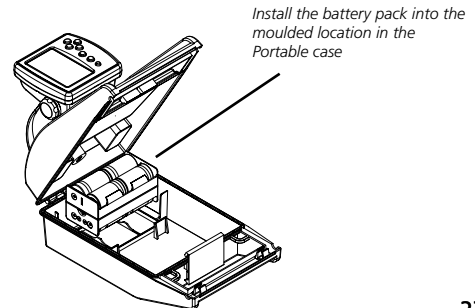

Index

A	
Accessories	iii
Adjust the Scroll Speed	16
Adjustment Bar	12
Alarms	22, 35
Arrow Keys	10
B	
Batteries	37
Battery Voltage (alarm)	23
Battery Voltage (display)	20
Beeper	24
C	
Calibration	25
Chart	15
Contrast	24
D	
Deep Water	23
Depth	26
Depth Line	18
Display	vi
Display Installation.....	7
E	
Enter Key	10
F	
Factory Setup	27
Fish Alarm	22
Fish Symbols	15
Fishfinder 240 Portable	36
Flasher	19
Flush Mount	8
G	
Gain	14

Index

I	
In-hull Installation	3
Installing the Display	7
K	
Keel Offset	25
Keypad	10
L	
Limited Warranty	ii
M	
Memory	27
Messages	35
N	
NMEA Output	24
Noise Reject	18
Number Size	20
Numbers	20
O	
Operation	28
P	
Portable Case	36
Power Key	10
R	
Range	12
Remember	27
S	
Scale	17
Scroll Speed	16
Setup Key	10
Setup Menu	15
Shallow Water	22
Simulator	19

Index

S	
Software Version	27
Specifications	34
Speed	1, 26
Speed Sensor	25
Suction Cup Transducer	36
System	24
T	
Table of Contents	iv
Temperature	21, 26
Testing the Installation	9
Tools	18
Transducers	1
Transom Mount Installation	2
Trolling Motor Installation	4
U	
Understanding Sonar	28
Units	26
V	
View	13
W	
Water Type	25
Whiteline	16
Wiring Harness Installation	5, 6
Z	
Zoom	13



© 1999 - 2000 GARMIN Corporation

GARMIN International, Inc.
1200 East 151st Street, Olathe, Kansas 66062, U.S.A.

GARMIN (Europe) Ltd.
Unit 5, The Quadrangle, Abbey Park Industrial Estate, Romsey, SO51 9AQ, U.K.

GARMIN (Asia) Corporation
No. 68, Jangshu 2nd Road, Shijr, Taipei County, Taiwan

www.garmin.com

Part Number 190-00155-10 Rev. A